

# User Guide

## Automatic Transfer Switch (ATS)



# Table of Contents

1. Introduction.....	2
2. Product Overview .....	2
3. Important Safety Warnings .....	3
4. Operation Indicators & Status .....	3
5. Installation.....	5
6. Operation .....	6
7. Communication Port .....	6
8. Trouble Shooting .....	8
9. Specifications.....	9
10. Appendix:.....	10

# 1. Introduction

This ATS product is designed with two independent power inlets to supply power to the load from a primary power source. Should primary power source fail, the secondary will automatically back up the connected equipment without any interruption. The transfer time from one line to another is seamless to the connected equipment. After switching to a secondary power source, the ATS can also switch power back to the primary input when power to the primary input is restored.

## **Package contents:**

- ATS module
- User manual
- mounting brackets

# 2. Product Overview

## Front View:

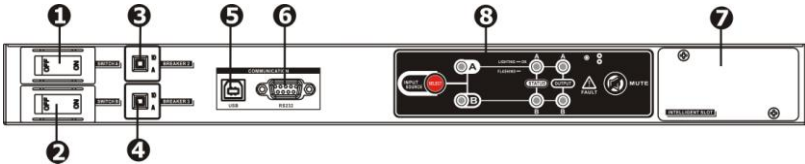

- 1 Power switch for input source A
- 2 Power switch for input source B
- 3 Circuit breaker for output 2
- 4 Circuit breaker for output 3
- 5 USB communication port
- 6 RS-232 communication port
- 7 Communication slot
- 8 Operation indicators (please refer to section 4 for the details)

## Back View

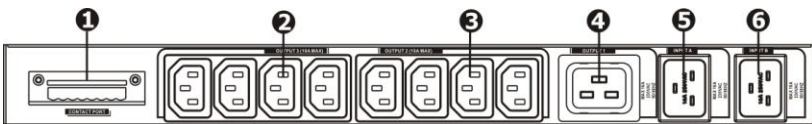

- 1 Contact port (please refer to section 7 for the details)
- 2 Output receptacles "Output 3" (IEC 10A)
- 3 Output receptacles "Output 2" (IEC 10A)
- 4 Output receptacle "Output 1" (IEC 16A)
- 5 Input source A connector
- 6 Input source B connector

### 3. Important Safety Warnings

**Before using the unit, please read all instructions and cautionary markings on the unit, this manual and the batteries.**

**WARNING!!** The ATS must be connected to earth when in use.

In line with current regulations, only use the cables that have been supplied with the machine. The power supply socket must be easily accessible to the operator.

**WARNING!!** The ATS has been designed exclusively to operate indoors. It is advisable to install it in areas where no inflammable liquids or gases, or other harmful or noxious substances, have been stored.

**ATTENTION!!** A soft damp cloth may be used to clean the outside of the machine (always with the system disconnected from the mains power supply and users).

Do not use any type of solvent as this may damage the external finishing of the machine.

**ATTENTION!!** The ATS has been designed exclusively for professional use.

**NOTE:** These instructions may be modified by the wiring regulations in force in the country where the ATS is purchased.

### 4. Operation Indicators & Status

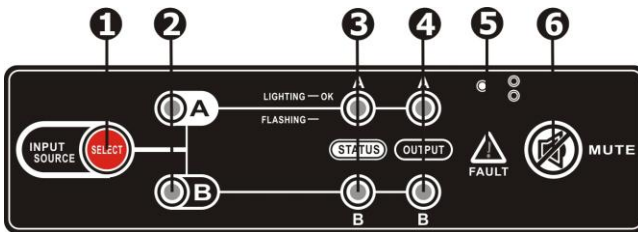

- ❶ Source preference selector
- ❷ Priority setting LEDs
- ❸ Power source status LEDs
- ❹ Output source LEDs
- ❺ Fault indicator
- ❻ Alarm mute button

<b>Indication type</b>	<b>LED description</b>	<b>LED status</b>	<b>Condition</b>	<b>Alarm</b>
Priority setting LEDs	Source A (●)	ON	Source A is priority	OFF
	Source B (●)	OFF		
	Source A (●)	OFF	Source B is priority	OFF
	Source B (●)	ON		
Power source status	Status of source A (●)	OFF	Inlet A has no power input	OFF
		ON	Inlet A has power input, and power is OK	OFF
		Flashing	Inlet A has power input, but power is out of SPEC	OFF
	Status of source B (●)	OFF	Inlet B has no power input	OFF
		ON	Inlet B has power, and power is OK	OFF
		Flashing	Inlet B has power input, but power is out of SPEC	OFF
Output status	Output from source A (●)	ON	Power A is output	OFF
	Output from source B (●)	OFF		
	Output from source A (●)	OFF	Power B is output	OFF
	Output from source B (●)	ON		
	Output from source A (●)	OFF	NO OUTPUT	OFF
	Output from source B (●)	OFF		
Alarm	Fault (●)	OFF	Alarm not present	OFF
		ON	Alarm present	Continuously

## 5. Installation



**NOTE:** Before installation, please inspect the unit. Be sure that nothing inside the package is damaged.

### Mounting the Unit

The unit can be mounted in a standard 19" rack. Fasten the mounting brackets to the unit using the screws provided. With brackets attached securely, users can mount the unit in a standard 19" rack as shown below.

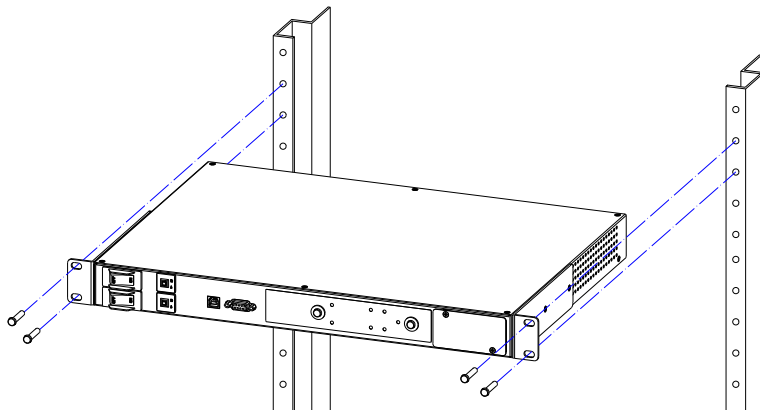

**NOTE:** If the temperature around the unit will rise above 40 °C, ventilation is required

### Connecting the Unit

For connecting the ATS, plug "input source A connector" and "input source B connector" to the two independent power sources or UPSs depending using the SCHUCKO-IEC or IEC-IEC 16A cables supplied.

Plug the user load to the output 10A ("Output 1 and 2") or 16A ("Output 3") sockets depending on user's requirements.

## 6. Operation

### Power On/Off

Put the input power switch in “ON” position. The output will then be supplied by the source set as selected.

### Setting priority of power source

It is possible to set the power source preference to supply the output by pushing the button of “source preference selector”. The default power source is “Source A”.

Function	Description	Default	Possible configuration
Source preference selector	Selection of input that normally supplies the load	Source A	<ul style="list-style-type: none"> <li>Source A</li> <li>Source B</li> </ul>

## 7. Communication Port

The ATS is supplied with the following communication ports:

- Serial port is available with RS232 com. port and USB com. port on the front panel.  
NOTE: the use of one port automatically excludes the other.
- Contacts port on the rear panel.

### Serial Ports: RS-232 & USB connectors

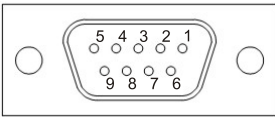

RS-232 connector

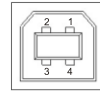

USB connector

PIN #	NAME	TYPE	SIGNAL
1			
2	TX	OUT	Serial line TX
3	RX	IN	Serial line RX
4			
5	GND	POWER	
6	+12V	POWER	
7			
8			
9			

PIN #	SIGNAL
1	VBUS
2	D-
3	D+
4	GND

**NOTE:** The utilization of the communication port is optional and it is not necessary for the correct functioning of the ATS.

## Contact Ports

The contacts port is formed using six (6) pins numbered from left to right (see fig. 1), which can be connected to an external monitoring system (such as a BMS) in order to monitor the operational status of the ATS.

The external equipment must respect the voltage and current characteristics of contacts port.

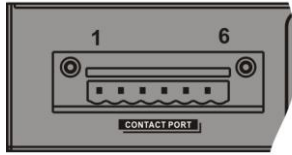
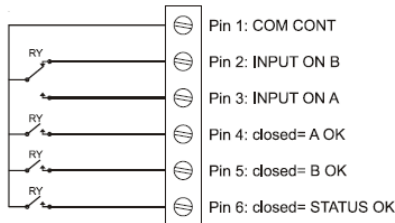

**Fig. 1: Focus on contacts port.**

The contacts port provides the following pins:

- Pin 1: common contact.
- Pin 2: "Source B" active contact (if the contact between "pin 1" and "pin 2" is closed, output is supplied by "Source B").
- Pin 3: "Source A" active contact (if the contact between "pin 3" and "pin 1" is closed, output is supplied by "Source A").
- Pin 4: "Source A" status OK contact (if the contact between "pin 4" and "pin 1" is closed, "Source A" is present and regular).
- Pin 5: "Source B" status OK contact (if the contact between "pin 5" and "pin 1" is closed, "Source B" is present and regular).
- Pin 6: Status OK contact (if the contact between "pin 6" and "pin 1" is closed, ATS functioning status is regular).

The following diagram shows the functioning of the contacts port.



**Fig. 2: Contacts port basic diagram.**

**ATTENTION:** The pins of the contact port are able to carry maximum current of 8A and maximum voltage of 250Vac.



## 8. Trouble Shooting

Use the table below to solve minor problems.

Problem	Possible Cause	Solution
The ATS with the mains voltage present, does don't turn on. (The LEDs does not flash and no alarm sounds.)	No connection with input plugs	Connect the mains to the input plugs as indicated in the installation section.
	Input switch in "OFF" position	Turn the input switches in "ON" position.
	Input power failure	Check that the mains voltage is present or check if the UPS supplying the ATS is powered on.
	Protective device upstream activated	Reset the protective device. <u>Warning:</u> check that there is no overload or short-circuit at the output of the UPS.
The load is not powered.	No connection with output sockets	Connect the load to the output sockets
	Intervention of 10A thermal protection	The thermal protection device will operate in the event of a short circuit or overload on one of the 10A output sockets. The thermal protection can be reset by pushing the button in which will result in the power being reconnected to the load. Therefore prior to attempting a reset of the thermal protection, please check the connected loads rating and/or determine if there are any problems. Then once reset, reconnect each load one at a time to ensure no problems exists.
The display shows nothing or provides incorrect information.	There is power supply problem in display.	Shut down the ATS completely and wait for a few seconds. Switch the ATS on again, if the problem persists, contact the nearest technical support centre.
The display is off but the load is powered.	There is power supply problem in display.	Contact the nearest technical support centre.

If there is any abnormal situations occur, which doesn't list above, please call the service people immediately for professional examine.

## 9. Specifications

<b>MODEL</b>	<b>ATS</b>
<b>INPUT</b>	
Input Voltage	230 VAC
Acceptable Input Voltage Range	207 - 253 VAC
Input Frequency	50 Hz/60 Hz
Input Current	16 A
<b>OUTPUT</b>	
Output Voltage	230 VAC
Maximum Output Current	10 A for IEC-C13 outlets 16 A for IEC-C19 outlet
<b>CONNECTION</b>	
Input	2 x IEC-C20 inlets
Output	8 x IEC-C13 1 x IEC-C19
Communication	USB/RS-232
<b>TRANSFER TIME</b>	9-12ms (Typical)
<b>PHYSICAL</b>	
Dimension, D X W X H (mm)	310 X 430 X 44
Net Weight (kgs)	3.65
<b>ENVIRONMENT</b>	
Operating Temperature	0-95 % RH @ -5°C- 45°C (non-condensing)

## 10. Appendix: Input Voltage and Frequency Thresholds

<b>FUNCTION</b>	<b>DESCRIPTION</b>	<b>DEFAULT SETTING</b>
Acceptable input voltage range for Source A	Source A will be power source during this range. When input voltage of source A is beyond this range, ATS will automatically switch to power from Source B.	180V – 258V
Return voltage point for Source A	When input voltage of Source A is back to normal, the ATS will switch back to Source A. (Setting Source A as priority power source and Source B is powering)	Low point: 190V High point: 248V
Acceptable input voltage range for Source B	Source B will be power source during this range. When input voltage of source B is beyond this range, ATS will automatically switch to power from Source A.	180V – 258V
Return voltage point for Source A	When input voltage of Source B is back to normal, the ATS will switch back to Source B. (Setting Source B as priority power source and Source A is powering)	Low point: 190V High point: 248V
Acceptable input frequency for Source A	Source A will be power source during this range. When input frequency of source A is beyond this range, ATS will automatically switch to power from Source B.	45Hz – 55Hz
Acceptable input frequency for Source B	Source B will be power source during this range. When input frequency of source B is beyond this range, ATS will automatically switch to power from Source A.	45Hz – 55Hz